

- 87%
- 
- 0.95
- 4kV, 6kV
- 
- IP67
- SELV
- 5

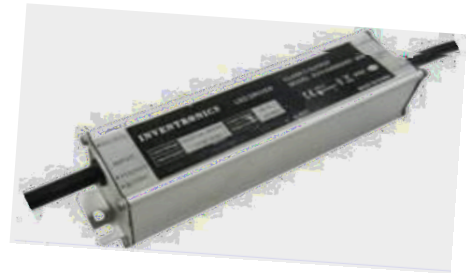

EUV-036SxxxSV

36W IP67

90~ 305Vac

24 Vdc	90 ~ 305 Vac	0~1500 mA	36 W	85%	0.96	0.95	EUV-036S024SV
36 Vdc	90 ~ 305 Vac	0~1000 mA	36 W	86%	0.96	0.95	EUV-036S036SV
48 Vdc	90 ~ 305 Vac	0~750 mA	36 W	87%	0.96	0.95	EUV-036S048SV

- 1 220Vac, 100%
- 2 220Vac 100%
- 3 SELV

	90 Vac	-	305 Vac	
	47 Hz	-	63 Hz	
	-	-	0.75 mA	IEC60598-1; 240Vac/ 60Hz
	-	-	0.6 A	100Vac 100%
	-	-	0.3 A	220Vac 100%
	-	-	60 A	220Vac 25 10%-
I <sup>2</sup> t	-	-	0.2 A <sup>2</sup> s	10% = 210 μs

	0.90	-	-	100~ 277Vac 75%~ 100%
	-	-	20%	

	-5%Vo	-	5%Vo	
(pk-pk) Vo = 24 V Vo = 36 V Vo = 48 V	- - -	- - -	3 V 4 V 4 V	: 20MHz 0.1uF 10uF
/	-	-	10%Vo	
Vo = 24 V Vo = 36 V Vo = 48 V	- - -	- - -	28V 40V 52V	
	-	-	±2%	100%
	-	-	±3%	
	-	0.6 s	1.0 s	120Vac 75%~ 100%
	-	0.3 s	0.5 s	220Vac 75%~ 100%
	-	0.2%/°C	-	=0°C~Tc

25°C

@ 120Vac: Vo = 24 V Vo = 36 V Vo = 48 V	83% 84% 85%	84% 85% 86%	- - -	100% 25
@ 220Vac: Vo = 24 V Vo = 36 V Vo = 48 V	84% 85% 86%	85% 86% 87%	- - -	100% 25
@ 277Vac: Vo = 24 V Vo = 36 V Vo = 48 V	84% 85% 86%	85% 86% 87%	- - -	100% 25
	-	-	6 W	
	371,000 hours	-	-	120Vac , 25 80% (MIL-HDBK-217F)

	-	111,700 Hours	-	120Vac , 80% 60
	-40 °C	-	+90 °C	
	-40 °C	-	+70 °C	5 : 10% RH to 100% RH
	-40 °C	-	+85 °C	: 5% RH to 100% RH
(L × W × H)	6.77 × 1.77 × 1.38			7.60 × 1.77 × 1.38
(L × W × H)	172 × 45.0 × 35.0			193 × 45.0 × 35.0
	-	520 g	-	

25°C

CE	EN 61347-1, EN61347-2-13
CCC	GB 19510.1, GB 19510.14
KS	KS C 7655
EN 55015 <sup>(1)</sup>	Conducted Emission Test & Radiated Emission Test
EN 61000-3-2	Harmonic current emissions
EN 61000-3-3	Voltage fluctuations & flicker
<b>EMS</b>	
EN 61000-4-2	Electrostatic Discharge (ESD): 8 kV air discharge, 4 kV contact discharge
EN 61000-4-3	Radio-Frequency Electromagnetic Field Susceptibility Test-RS
EN 61000-4-4	Electrical Fast Transient / Burst-EFT
EN 61000-4-5	Surge Immunity Test: AC Power Line: line to line 4 kV, line to earth 6 kV
EN 61000-4-6	Conducted Radio Frequency Disturbances Test-CS
EN 61000-4-8	Power Frequency Magnetic Field Test
EN 61000-4-11	Voltage Dips
EN 61547	Electromagnetic Immunity Requirements Applies To Lighting Equipment

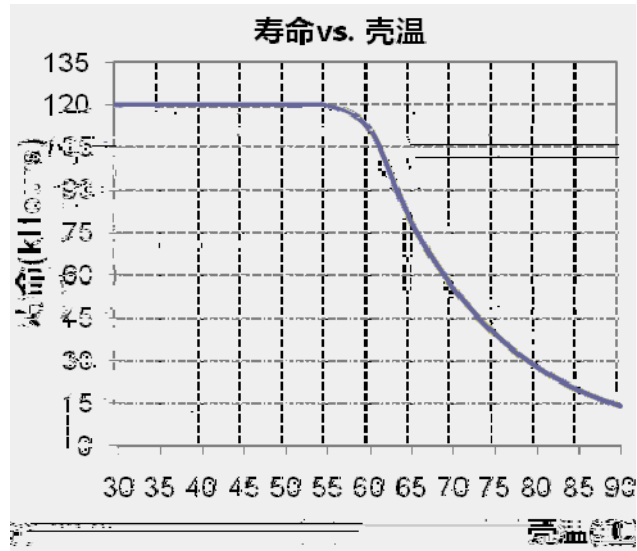

EUV-036S024SV  
效率 vs. 输出电流

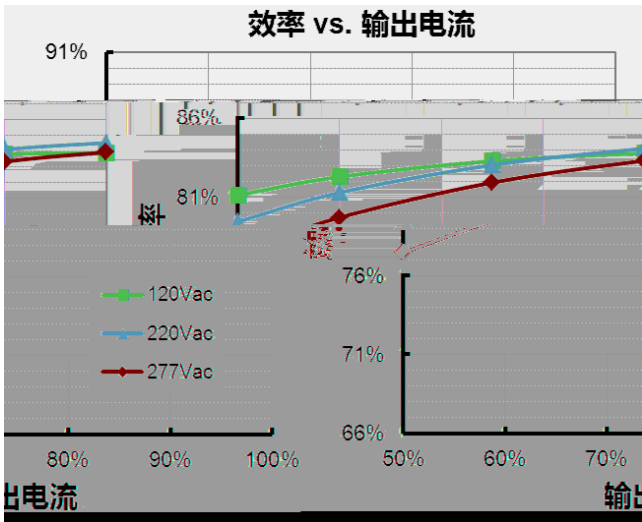

EUV-036S036SV  
效率 vs. 输出电流

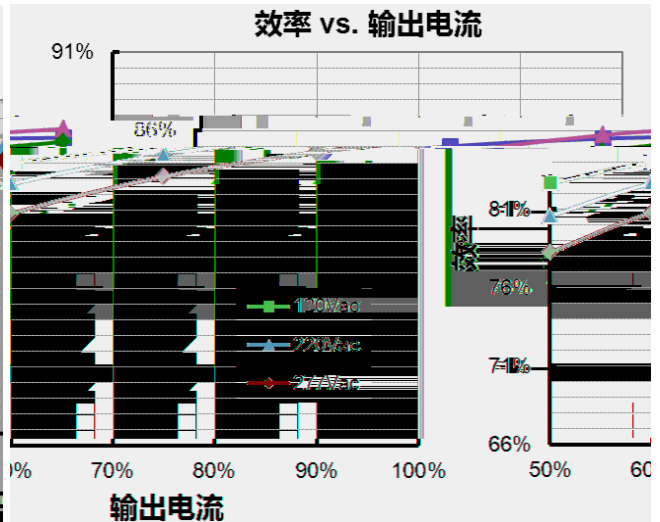

EUV-036S048SV  
效率 vs. 输出电流

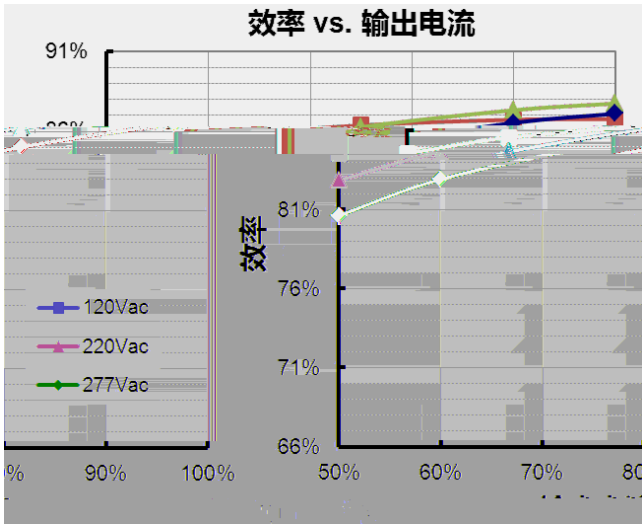

功率因数 vs. 负载

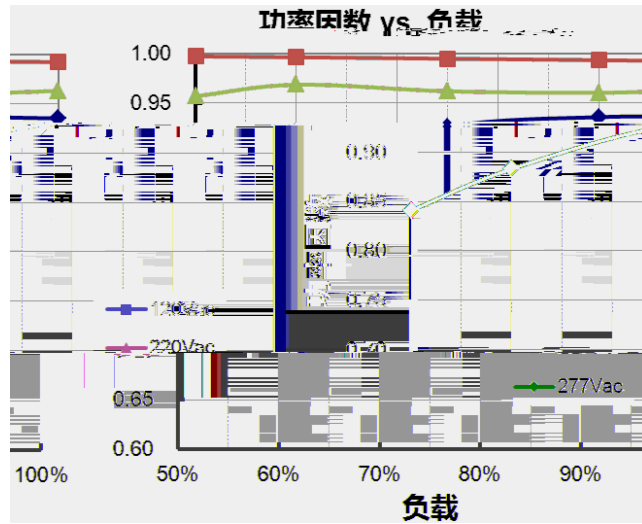

	1.1 lo	1.4 lo	1.70 lo	

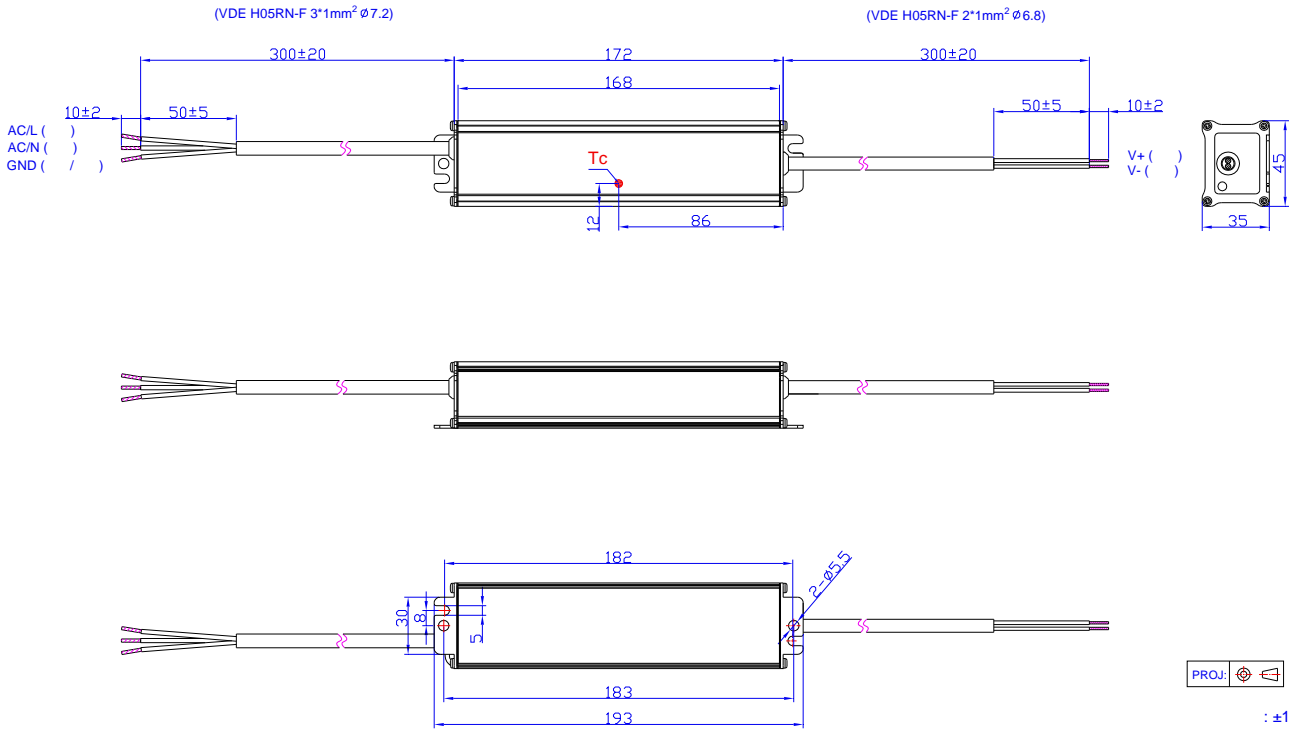

2002/95/EU

2012-04-24	A		/	/
2012-05-25	B		/	/
2012-06-06	C		/	
			/	
2012-07-03	D		/	
2012-7-12	E		/	
2012-7-30	F		-35	-40
2012-8-21	G		/	
		I <sup>2</sup> t	/	
			/	
		PF	/	
2012-11-27	H		Min 50,000hrs	Typical 111,700hrs
			/	
			/	
2017-09-11	I		/	
			/	
		@ 277Vac	/	
			/	
			/	
		CCC	/	
		KS	/	
		EMI	/	
			/	
			/	
		(L x W x H) 6.77 x 1.67 x 1.34	6.77 x 1.77 x 1.38	
		(L x W x H) 172 x 42.4 x 34.0	172 x 45.0 x 35.0	
		480 g	520 g	

2017-09-11	I	-	/	
			/	
2018-04-12	J	PSE	/	
			/	
		- CCC	/	